



TUESDAY JUNE 3 TO THURSDAY JUNE 5 • 2025
OSHWAL CENTRE • NAIROBI • KENYA

EXHIBITOR MANUAL

Updated: 10/03/2025 13:10

INDEX

	Page
1. GENERAL INFORMATION	
1.1 VENUE ADDRESS	3
1.2 IMPORTANT TIMES & DATES	3
1.3 HOTEL INFORMATION	3
1.4 EXHIBITION BADGES.....	3
1.5 EXHIBITION DIRECTORY	4
1.6 ADDITIONAL PROMOTION TOOLS.....	4
1.7 OTHER SERVICES	4
1.8 VISITOR ADMISSION POLICY	4
1.9 FLOWER DESIGNING	4
1.10 BEST STAND DESIGN COMPETITION	4
1.11 OFFICIAL EXHIBITION PARTY	4
 2. STAND CONSTRUCTION, FURNISHINGS & OTHERS	
2.1 STAND CONSTRUCTION PACKAGE RENTAL DETAILS.....	5
2.2 FLOORSPACE ONLY RENTAL DETAILS	5
2.3 RENTAL FURNISHINGS & OTHERS	6
2.4 CATERING.....	6
2.5 INSURANCE	6
 3. SHIPPING INFORMATION	6
 4. OBLIGATORY ORDER FORMS	
ORDER FORM 1 OBLIGATORY SET UP & BREAK DOWN BADGES	8
ORDER FORM 2 OBLIGATORY EXHIBITOR BADGES.....	9
ORDER FORM 3 OBLIGATORY EXHIBITOR DIRECTORY LISTING	10
 5. NON-OBLIGATORY ORDER FORMS	
ORDER FORM 4 STAND CONSTRUCTION PACKAGE	12
ORDER FORM 5 FASCIA BOARD TEXT FOR YOUR STAND	13
ORDER FORM 6 ADVERTISING	14
ORDER FORM 7 WEBSITE LINK	15
ORDER FORM 8 CUSTOMER INVITATION LINK	16
ORDER FORM 9 ELECTRICAL OUTLETS	17
ORDER FORM 10A FURNISHINGS	18
ORDER FORM 10B FURNISHINGS	19
ORDER FORM 11 AUDIOVISUALS & SUPPLIES	20
ORDER FORM 12 STORAGE IN YOUR STAND	21
ORDER FORM 13 FLOWER DESIGNING	22
ORDER FORM 14 OFFICIAL EXHIBITION PARTY TICKETS	23

1. GENERAL INFORMATION

1.1. VENUE ADDRESS

Oshwal Centre

Ms. Michelle Mwangi
Phone: +254-727-085299
P.O. Box 40638 - 00100 GPO
Ring Road Parklands
Nairobi, Kenya

The Visa Oshwal Center is a facility in which the highest standards are common practice. The hall is exclusively vegetarian (food without e.g. onion, garlic, eggs, etc.), alcohol free and non-smoking. On any given day the centre can easily accommodate up to 4.500 people throughout the entire complex. This makes it one of the largest facilities in East Africa.

1.2. IMPORTANT TIMES & DATES

- **SET UP.**

Sunday June 1	08:00 hrs. - 22:00 hrs.
Monday June 2	08:00 hrs. - 22:00 hrs.

All exhibits **must** be ready by 22:00 hrs. on Monday evening, June 2.
- **BREAK DOWN.**

Thursday June 5	18:00 hrs. - 22:00 hrs.
Friday June 6	08:00 hrs. - 14:00 hrs.
- **HOURS TO REFRESH AND/OR REDESIGN YOUR FLOWERS.**

Tuesday June 3	18:00 hrs. - 20:00 hrs.
Wednesday June 4	08:00 hrs. - 10:00 hrs.
Wednesday June 4	18:00 hrs. - 19:00 hrs.
Thursday June 5	08:00 hrs. - 10:00 hrs.
- **EXHIBITION DAY TO DAY PROGRAMME**

Tuesday June 3	9:00 hrs. - 10:00 hrs. <i>Official opening ceremony</i> 10:00 hrs. - 18:00 hrs. <i>Exhibition hours for trade visitors only.</i>
Wednesday June 4	10:00 hrs. - 18:00 hrs. <i>Exhibition hours for trade visitors only.</i> 19:00 hrs. - 23:00 hrs. <i>Official exhibition party.</i>
Thursday June 5	10:00 hrs. - 16:00 hrs. <i>Exhibition hours for trade visitors only.</i>

1.3. HOTEL INFORMATION

IFTEX 2025 has selected Flight & Safaris International Ltd. as their preferred travel partner.

Flight & Safaris International Ltd.

P.O. Box 9052-00200
Nairobi, Kenya
Contact : Mrs. Winnie Akinyi
Phone : +254-20-2212645 • +254-20-3511805
Cell phone : +254-722-862920 • +254-733-639351
Email : info@flightsafaris.com / flightsafaris2010@gmail.com

Flight & Safaris International Ltd. is a Tours, Travel and Car Hire Company based in Nairobi, Kenya. They specialize in providing personalized and reliable services to their customers. The Company was registered in October 2007 and started its full-time operations on February 2008. The company has two directors with the Managing Director having over 18 years of experience in the Tourism Industry. They deal with Domestic and International Tourism and liaise with Airlines and Hotels to provide the best to their customers.

Hotel options as well as details can be found on: www.iftex.org.

1.4. EXHIBITION BADGES

- **SET UP & BREAK DOWN BADGES.**
The set up & break down badge is a personal identification, and it will give you access to the hall ONLY during set up and break down hours. It WILL NOT give access during exhibition hours.

Every exhibiting company will receive the required number of set up & break down badges which can be requested through OBLIGATORY ORDER FORM 1 on page 8. Exhibitors are required to send this form back before Friday April 25th.

Please note: All badges are personal, non-transferable, and valid only for people over 18 years old. Random ID checks will be executed therefore please carry a valid ID at all times.

Badges can be picked up at the registration desk during the following hours:

Sunday June 1	08:00 hrs. - 18:00 hrs.
Monday June 2	08:00 hrs. - 18:00 hrs.
Thursday June 5	12:00 hrs. - 18:00 hrs.

Please note: If you request an exhibitor badge, you will not need an extra set up and break down badge.

- **EXHIBITOR BADGES.**
The exhibitor badge is your personal identification, and it will give you access to the exhibition floor at all times. Every exhibiting company is entitled to a certain number of badges based on the size of their stand space as follows:
9 to 18 sq. meters: 5 Badges
19 to 27 sq. meters: 10 Badges
28 to 36 sq. meters: 15 Badges
37 or more sq. meters: 20 Badges.

Badges can be requested through OBLIGATORY ORDER FORM 2 on page 9. Exhibitors are required to send this form back before Friday April 25th.

Badges can be picked up at the registration desk during the following hours:

Sunday June 1	08:00 hrs. - 18:00 hrs.
Monday June 2	08:00 hrs. - 18:00 hrs.
Tuesday June 3	09:00 hrs. - 18:00 hrs.
Wednesday June 4	08:00 hrs. - 18:00 hrs.
Thursday June 5	08:00 hrs. - 14:00 hrs.

Please note: All badges are personal, non-transferable and only for people over 18 years old. Exhibitors must carry a valid ID at all times, as the name on the badge will need to match with the name of your ID.

1.5. EXHIBITION DIRECTORY

- **EXHIBITION DIRECTORY LISTING.**

For IFTEX 2025 an exhibition directory will be published and distributed among trade visitors. It will contain company name, address, and contact details of your company in alphabetical order. The English directory is a practical resource for visitors and is, above all, an intensively used reference book. Inclusion in this official directory is free and can increase exposure for your participation in the fair during and after the event.

Your company will also be included in the product index in alphabetical order.

Please fill out [OBLIGATORY ORDER FORM 3](#) on page 10 of this manual. Exhibitors are required to send this form back before Friday April 25th.

- **ADVERTISING.**

An additional way to highlight your presence at IFTEX 2025 is to take an advertisement in the exhibition directory. This is optional.

Please fill out [NON-OBLIGATORY ORDER FORM 6](#) on page 14 if you want to publish an advertisement in the exhibition directory. Exhibitors are required to send this form and the artwork back to our offices before Friday April 25th.

1.6. ADDITIONAL PROMOTION TOOLS

- **WEBSITE LINK.**

As an extra tool of advertising, HPP Worldwide offers you the possibility to have a website link to your own company website. Visitors to the IFTEX 2025 website (www.iftex.org) can click on your company name in the exhibitor list and will be directly linked to your website/page. The link provides visitors an opportunity to get acquainted with your company and your line of products and/or services given beforehand.

If you would like to have a website link, please fill out [NON-OBLIGATORY ORDER FORM 7](#) on page 15. Exhibitors are required to send this form back before Friday April 25th.

- **CUSTOMER INVITATION LINK.**

You can order*, free of charge, your personalized customer invitation link, which you can forward to any of your customers who you would like to invite to IFTEX 2025.

For this option, please fill out the [NON-OBLIGATORY ORDER FORM 8](#) on page 16. Exhibitors are required to send this form back before Friday April 25th.

*subject to our visitor admission policy as outlined in paragraph 1.8 of this manual.

1.7. OTHER SERVICES

For special stand designs, background printing and decoration of your stand please contact:

HPP Worldwide

Contact : Mrs. Patricia Peláez
Phone : +31-20-6622482
Email : patricia@hpp.nl

1.8. VISITOR ADMISSION POLICY

Since this exhibition is a trade show, visitors will need to be qualified. Qualified visitors are either buyers and/or growers of fresh cut flowers. You must be 18 years of age or older to visit. Children and/or babies will not be allowed on the exhibition floor.

It is recommended to pre-register on time to avoid long waiting time on site at the registration desk of the exhibition hall. For online registration go to: www.iftex.org and click on "I Want to Visit" in the left top menu.

For further questions regarding visitor registration, contact Mr. Jasper van Dijk at: jasper@hpp.nl

1.9. FLOWER DESIGNING

You can request professional flower designing for your stand on IFTEX 2025. HPP offers the services of its professional team of designers as an extra way to highlight your participation. The service includes rental of wooden pillar on the colour of choice, vase rental, flower designing, daily maintenance and disposal at the end of the exhibition.

To request flower designs, please fill out [NON-OBLIGATORY ORDER FORM 13](#) on page 22. Exhibitors are required to send this form back before Friday April 25th.

1.10. BEST STAND DESIGN COMPETITION

All stands will be judged on criteria such as: overall presentation, floral design, flower quality, color combination, technical value, theme, innovations, and visual and physical aesthetics. You become part of this event automatically and free of charge.

A distinction will be made between perishable and non-perishable stands. For each category, there will be a best decorated stand, which will be awarded with a platinum award. The rest of the stands will be competing for the gold, silver and bronze awards.

1.11. OFFICIAL EXHIBITION PARTY

The Official IFTEX 2025 Party will take place on Wednesday, June 4th from 19:00 hrs. to 23:00 hrs. Exhibitors and visitors will enjoy delicious food, drinks, music, whilst having the chance to socialize among other exhibitors and visiting buyers.

Regular exhibitors will receive 4 entry tickets free of charge per stand regardless of stand size. Additional tickets can be ordered at a price of € 35.00 per ticket and will be invoiced after the show. Please fill out the [NON-OBLIGATORY ORDER FORM 14](#) on page 23, in case you want to order extra tickets. Exhibitors must send this form back before Friday April 25th.

2. STAND CONSTRUCTION, FURNISHINGS & OTHERS

2.1. STAND CONSTRUCTION PACKAGE RENTAL DETAILS

Exhibitors, who are wishing to do so, can order one of the rental stand construction options offered by the organizer via **NON-OBLIGATORY ORDER FORM 4** on page 12 of this manual. The stand construction package facilitates exhibitors and offers various options to particularize their presentations. The stand is built by professional stand builders.

The Stand Construction Package includes:

- Back- and side system walls (white panels, 2.50 meters high)
- one, two, three or four fascia boards (depending on the location of the stand), which displays the company name.
- Gray carpet.
- 1 standard low table + 3 standard chairs per every 9 m².
- 1 electricity outlet (1 Kw).
- 1 spotlight per every 3 m².
- Daily Cleaning.

Rental price per m² is € 65.00 for the full package. In case you have already chosen for this stand construction package through your contract, please fill out **NON-OBLIGATORY ORDER FORM 5** on page 13 of this manual. Exhibitors are required to send back this form before Friday April 25th.

- Please consider that the back and side walls of your stand are hard white panels of 1 meter width and 2.50 meters height.
- It is forbidden to damage, drill, paint, and weld or modify in any way the hall floor. You will be charged for any repairs or renewals.
- It is not allowed to paint, drill, hammer, stick non removal materials hang heavy structures or damage in any other way the panels and/or fascia boards of your stand. You will be charged for any repairs or renewals.

Example of Modular Octanorm Shell Scheme System Construction

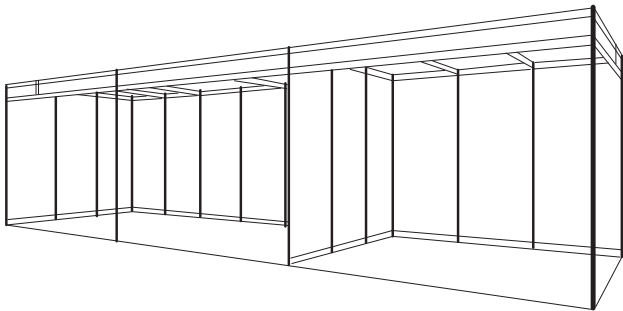

Shell Scheme Dimensions of the Octanorm Stand Construction

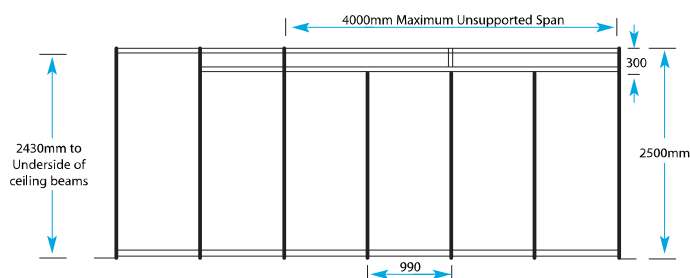

Panel Dimensions of the Octanorm Stand Construction

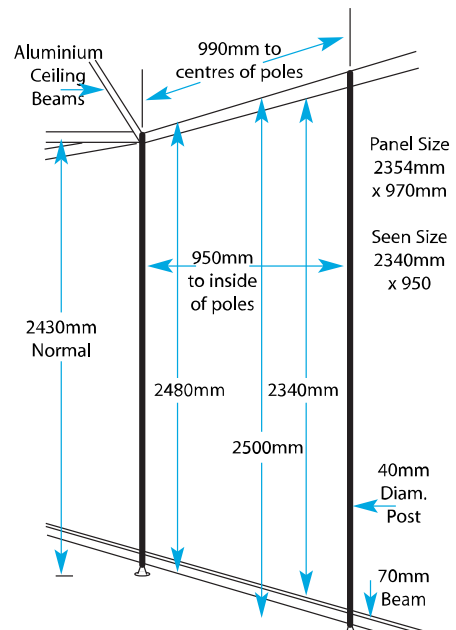

2.2. FLOORSPACE ONLY RENTAL DETAILS

All stand designs must be sent to the organizer, complete with dimensions, before Saturday April 26th for approval.

Please send your stand design to:

HPP Worldwide

Contact : Mrs. Patricia Peláez
Phone : +31-20-6622482
Email : patricia@hpp.nl

Exhibitors who have chosen the floorspace only option need to follow the following regulations:

The maximum construction height is 2.50 meters above floor level. No structure of any kind may rise more than 2.50 meters above floor level if written permission from the organizer has not been obtained. In case you any own structure is planned, the exhibitor needs to contact Mrs. Patricia Peláez before Saturday April 26th, for further information and approval: T: +31-20-6622482 • E: patricia@hpp.nl.

Please note that ANY structure should be prefabricated. Under no circumstance it is allowed to saw, paint, or build ANY structure inside the exhibition halls.

If approval is obtained and stand structures are higher than the permitted wall height of 2.50 meters, the exhibitor must neatly finish off the sides on the adjoining stands. At places where the stand divisions border other stands, exhibitors are only allowed to erect sets or walls which are higher than the permitted wall height of 2.50 meters at a distance of 1 meter from the dividing wall. This rule may be deviated from, if exhibitors on adjoining stand state, in writing that they have no objections to structures higher than 2.50 meters inside the 1 meter referred to. In this event, the exhibitor must submit a copy of the signed permission to the organizer before stand building commences.

Floors, walls and other parts of the building must not be damaged by drilling holes or by nails, adhesive, etc. All Stands should be self-standing. Please keep in mind that all sides facing aisles must remain

open. In the case of island stands, please note that it is not allowed to close or block more than 40% of any side facing aisles. It is not allowed to attach any kind of material to the exhibition hall. The stand locations are indicated by marks on the floor. It is advisable to check in case of doubt.

Please Note: No dividing walls will be erected by the organizer. All exhibitors must erect the dividing walls themselves. The regulation standard wall height is 2.50 meters. It is not allowed to have a fully closed ceiling.

The floor of the stand must be properly finished by means of laying floor covering such as carpeting. Exhibitors will receive an invoice for the costs of clearing up any adhesive tape left on the floor of the hall after the exhibition.

Written permission must be obtained from the organizer for the use of special floor covering (concrete tiles, sand, gravel, etc.). Plastic sheeting must be laid on the floor before materials of this kind can be brought in. It is not allowed to paint or glue directly to the floors of the exhibition hall.

It is forbidden to drill, paint, saw or weld inside the exhibition hall.

Exhibitors shall comply with the directions given by or on behalf of the organizer in respect of the construction, fitting out, safety, maintenance and dismantling of his stand. To the extent that they deem it necessary for the proper running of the exhibition, the organizer reserves the right to give binding directions to the exhibitors as regards the execution of work in or at, as well as the use of, the exhibition building and the adjacent grounds.

2.3. RENTAL FURNISHINGS & OTHERS

- **ELECTRICAL OUTLET.**

If you would like to order outlets for your stand, please fill out [NON-OBLIGATORY ORDER FORM 9](#) on page 17. Exhibitors are required to send this form back before Friday April 25th.

- **TABLES, CHAIRS & FURNISHING.**

We have different additional options of tables, chairs, and furnishings to choose from, if you want to order any additional or design furniture, please fill out [NON-OBLIGATORY ORDER FORM 10A](#) on page 18 or [NON-OBLIGATORY ORDER FORM 10B](#) on page 19. Exhibitors are required to send these forms back before Friday April 25th.

- **AUDIOVISUALS & SUPPLIES.**

Additional equipment, refrigerators, TV's and DVD players will also be available upon request. If you want to order any of these options, please fill out [NON-OBLIGATORY ORDER FORM 11](#) on page 20. Exhibitors are required to send this form back before Friday April 25th.

2.4. CATERING

The Shree Visa Oshwal Community Center is exclusively vegetarian (food without onion, garlic and eggs), and alcohol free.

Exhibitors will not be allowed under any circumstances to bring any foods or drinks products inside the building. No coffee machines are allowed on the grounds of the Oshwal Center without the approval of the organisers. Please note that in case of approval of a coffee machine, a special dedicated electrical connection might be required.

The organizer has arranged for a restaurant and 2 coffee corners, available during all 3 show days and during all show hours.

2.5. INSURANCE

HPP Worldwide is not responsible for any loss or damages to your exhibition material related to this exhibition. We recommend you take insurance for your exhibition materials.

3. SHIPPING INFORMATION

For all import matters into Kenya, you can contact Kuehne + Nagel Ltd. in Nairobi:

KUEHNE + NAGEL LTD

Jomo Kenyatta International Airport
Freight Road, 1st Freight Lane
P.O. Box 69979
NAIROBI - 00400
KENYA

Phone: +254-20-3827411 • +254-20-6600000

Phone: +254-722-205395 • +254-733-630052

Fax: +254-20-827417

CONTACT PERSONS FOR IFTEX 2025

IMPORTS CUSTOMER CARE SPECIALIST

Mr. Beliane Sytruc

Email: beliane.sytruc@kuehne-nagel.com

Direct Phone: +254-729-540177 • +254-709-853000

AIR LOGISTICS PRICING SPEACILIST (Quote/rate requests)

Ms. Beldinah Sabasi

Email: beldinah.sabasi@kuehne-nagel.com

Copy to: nancy.otieno@kuehne-nagel.com

Direct Phone: +254-718-475766 • +254-709-853000

AIR LOGISTICS CUSTOMER CARE TEAM LEADER (1st Escalation)

Mr. Joseph Chengo

Email: joseph.chengo@kuehne-nagel.com

Direct Phone: +254-708-990339 • +254-709-853000

AIR LOGISTICS CUSTOMER CARE MANAGER (2nd Escalation)

Mrs. Betty Luttah

Email: betty.luttah@kuehne-nagel.com

Direct Phone: +254-710-412184 • +254-709-853000

Send shipment status reports and rates requests to ALL above email addresses. **Please copy nbo.ai@kuehne-nagel.com**

OBLIGATORY ORDER FORMS

(FORM 1 - 3)

IMPORTANT NOTICE

The deadline for sending back all order forms is Friday April 25th, 2025.
Please make sure to fill out all order forms in English and clear capital letters.

SET-UP & BREAK-DOWN BADGES		ORDER FORM 1		OBLIGATORY	
		To be returned before: Friday April 25th, 2025			
CONTACT	EMAIL	PHONE	FAX		
Mrs. Patricia Peláez	patricia@hpp.nl	+31-20-6622482	+31-20-6752326		

Company Name:	
Stand number:	
Contact Person:	

Set up & break down badges **WILL NOT** give you access to the hall during exhibition hours!

Please fill out the full name(s) and country to be put on the set up & break badge(s) with **CLEAR CAPITAL LETTERS**. HPP Worldwide will not be responsible for mistakes in the set up & break-down badges if this form is not clearly readable.

* If you request an exhibitor badge, you will not need a set up and break down badge.

#	COMPANY	FIRST NAME	LAST NAME	COUNTRY
1				
2				
3				
4				
5				
6				
7				
8				
9				
10				

Please note that a badge is required at all times in order to enter the hall!

* If you need more set up & break down badges simply copy this form.

ORDER CONFIRMATION
Please note that, if applicable, sending back this order form automatically means that you agree that the order will be placed and/or invoiced.

EXHIBITOR BADGES		ORDER FORM 2 OBLIGATORY	
		To be returned before: Friday April 25th, 2025	
CONTACT	EMAIL	PHONE	FAX
Mrs. Patricia Peláez	patricia@hpp.nl	+31-20-6622482	+31-20-6752326

Company Name:	
Stand number:	
Contact Person:	

The exhibitor badge will give you access to the hall during show hours as well as during the build-up & break-down period.

Please fill out the full name(s) and country to be put on the exhibitor badge(s) with **CLEAR CAPITAL LETTERS**. HPP Worldwide will not be responsible for mistakes in the exhibitor badges if this form is not clearly readable.

*** If you request an exhibitor badge, you will not need a set up and break down badge.**

#	COMPANY	FIRST NAME	LAST NAME	COUNTRY
1				
2				
3				
4				
5				
6				
7				
8				
9				
10				

Please note that a badge is required at all times in order to enter the hall!

* Please note there is a limitation to the number of badges based on the size of the stand space as follows:

- 9 to 18 sq. meters: 5 Badges.
- 19 to 27 sq. meters: 10 Badges.
- 28 to 36 sq. meters: 15 Badges.
- 37 or more sq. meters: 20 Badges.

ORDER CONFIRMATION
Please note that, if applicable, sending back this order form automatically means that you agree that the order will be placed and/or invoiced.

EXHIBITOR DIRECTORY LISTING		ORDER FORM 3		OBLIGATORY	
		To be returned before: Friday April 25th, 2025			
CONTACT		EMAIL		PHONE	
FAX					
Mrs. Patricia Peláez		patricia@hpp.nl		+31-20-6622482	
				+31-20-6752326	

The official exhibition directory will contain details of the company's profile and products or services of all exhibiting companies. Therefore, please fill out this form with the company information you would like to have published.

Company Name:		Stand number:	
Contact Person:			
Address:			
Zip Code		State:	
City:		Country:	
Phone:			
Email:		Website:	

***HPP Worldwide is not responsible for any mistakes or wrong information published in the show directory if this order form is not clear or has not been filled out with the required specifications.*

The exhibition directory will also contain a product index. Please indicate by ticking (☑) the activities or services that apply to your company:

- | | |
|---|---|
| <input type="checkbox"/> Air, Road & Sea Transportation & Freight Forwarding | <input type="checkbox"/> Flower Grower & Exporter |
| <input type="checkbox"/> Association | <input type="checkbox"/> Flower Importer / Exporter |
| <input type="checkbox"/> Automation, Computerization, Software | <input type="checkbox"/> Greenhouse Construction, Greenhouse equipment, climate control, internal logistics, irrigation |
| <input type="checkbox"/> Consultancy / Education | <input type="checkbox"/> Machines & Equipment |
| <input type="checkbox"/> Cooling, Refrigeration & Air Conditioning | <input type="checkbox"/> Packaging |
| <input type="checkbox"/> Fertilizers, Crop Protection, Peat, Compost, Potting soil & Substrates | <input type="checkbox"/> Trade magazines / Books / Publications |
| <input type="checkbox"/> Floricultural & Horticultural Products /Services | <input type="checkbox"/> Others: |
| <input type="checkbox"/> Flower Breeder / Propagator | |

ORDER CONFIRMATION
Please note that, if applicable, sending back this order form automatically means that you agree that the order will be placed and/or invoiced.

NON OBLIGATORY ORDER FORMS (FORM 4 - 13)

IMPORTANT NOTICE

The deadline for sending back all order forms is Friday April 25th, 2025.
Please make sure to fill out all order forms in English and clear capital letters.

ORDER CONFIRMATION

Please note that, if applicable, sending back this order form automatically means that you agree that the order will be placed and/or invoiced.

STAND CONSTRUCTION PACKAGE		ORDER FORM 4 NON - OBLIGATORY To be returned before: Friday April 25th, 2025	
CONTACT	EMAIL	PHONE	FAX
Mrs. Patricia Peláez	patricia@hpp.nl	+31-20-6622482	+31-20-6752326

Company Name:	
Stand number:	
Contact Person:	

Please note: This form only needs to be filled out if you have not ordered the stand construction package through your contract but would still like to do so.

	Stand construction package	Stand size in m ²	Price in € per m ²	Total Price in €
<input type="checkbox"/>	Includes: back- and side system walls (white panels, 2.50m high), fascia board with company name, gray carpet, 1 standard low table and 3 standard chairs per every 9m ² , 1 electricity outlet (1 Kw.), 1 spotlight per every 3m ² and daily stand cleaning.		€ 65.00	

*If you choose the Stand Construction package, please fill out form 5 on the next page of this manual.

ORDER CONFIRMATION
Please note that, if applicable, sending back this order form automatically means that you agree that the order will be placed and/or invoiced.

FASCIA BOARD TEXT FOR YOUR STAND		ORDER FORM 5		NON-OBLIGATORY	
		To be returned before: Friday April 25th, 2025			
CONTACT	EMAIL	PHONE	FAX		
Mrs. Patricia Peláez	patricia@hpp.nl	+31-20-6622482	+31-20-6752326		

Company Name:	
Stand number:	
Contact Person:	

Please note: This form only needs to be filled out only if you ordered the Stand construction package through your contract or through order form 4 of this manual.

Please write here below in **CLEAR CAPITAL LETTERS** the name of the company as you would like to have it on the fascia of your stand (the text will be all on one line only!):

Name to appear on Fascia text:	
---------------------------------------	--

If you wish, you can also order full colour logos for your fascia's:

Quantity	Description	Price in € per logo	Total Price in €
	Full colour fascia logos (20 cm. x 20 cm.) *	€ 60.00	€

* For bigger logos (only available for on your walls) prices will be quoted upon request.

Please note: If you request a logo or extra text for your fascia board, we will contact you for further details.

ORDER CONFIRMATION
Please note that, if applicable, sending back this order form automatically means that you agree that the order will be placed and/or invoiced.

ADVERTISING		ORDER FORM 6 NON-OBLIGATORY	
		To be returned before: Friday April 25th, 2025	
CONTACT	EMAIL	PHONE	FAX
Mrs. Patricia Peláez	patricia@hpp.nl	+31-20-6622482	+31-20-6752326

Company Name:	
Stand number:	
Contact Person:	

As an exhibitor you can place an advertisement in the official exhibition directory. To advertise in it, please complete this form. Size of the official exhibition directory will be A5 standard size (150 mm. in width x 210 mm. in height). Please make sure you have an extra 3mm trim space all around.

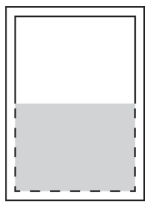

HALF PAGE

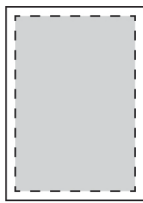

FULL PAGE

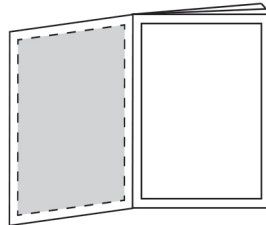

INNER FRONT COVER

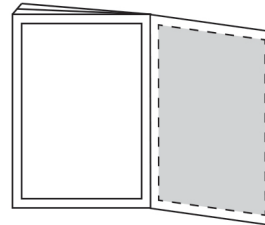

INNER BACK COVER

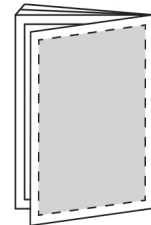

BACK COVER

All advertisements must be submitted according to the following technical specifications

- Format** : .TIFF, .PDF, JPG
- Resolution** : 300 dpi (minimum)
- Color Mode** : CMYK
- Full Page** : 150mm width x 210mm height
- Half Page** : 150mm width x 105mm height
- Bleed** : 3mm all around

CODE	Description	Quantity	Unit price in €	Total Price in €
AD001	Half Page (Black and White)		€ 200.00	
AD002	Half Page (Full Color)		€ 450.00	
AD003	Full Page (Black and White)		€ 350.00	
AD004	Full Page (Full Color)		€ 700.00	
AD005	Inner Front Cover (Full Color)		€ 950.00	
AD006	Inner Back Cover (Full Color)		€ 950.00	
AD007	Back Cover (Full Color)		€ 1,300.00	
Total amount in €				

*Artworks should be received no later than April 25th, 2025.

WEBSITE LINK		ORDER FORM 7 NON-OBLIGATORY To be returned before: Friday April 25th, 2025	
CONTACT	EMAIL	PHONE	FAX
Mrs. Patricia Peláez	patricia@hpp.nl	+31-20-6622482	+31-20-6752326

Company Name:	
Stand number:	
Contact Person:	

HPP Worldwide is pleased to offer you, free of charge, a link from the IFTEX website to your own website.

Visitors of the IFTEX 2025 website, www.iftex.org, can click on your company name in the list of exhibitors and will be directly linked to your website.

This link provides the visitor an opportunity to get acquainted with your company and you line of products.

If you would like to have a link to your own website, please fill out this form.

YES, I would like to have my website linked on www.iftex.org

Website:	http://www.
-----------------	-------------

ORDER CONFIRMATION
Please note that, if applicable, sending back this order form automatically means that you agree that the order will be placed and/or invoiced.

CUSTOMER INVITATION LINK		ORDER FORM 8		NON-OBLIGATORY	
		To be returned before: Friday April 25th, 2025			
CONTACT	EMAIL	PHONE	FAX		
Mrs. Patricia Peláez	patricia@hpp.nl	+31-20-6622482	+31-20-6752326		

Company Name:	
Stand number:	
Contact Person:	
Email Address:	

(Where the cc email of the registration will be sent to, *1 email address possible only*)

You can order free of charge your Personalized Customer Invitation Link, which you can forward by email to any of your customers who you would like to invite to IFTEX 2025.

By clicking on this link, the customer will go direct to the online registration form which must be filled out and sent back. You will receive a cc on the email that confirms you customer filled out the registration form online.

Please note: *Attending the Expo is open to trade visitors only and is subject to our admission policy as outlined in paragraph 1.8 in this manual, each registration will be reviewed and answered directly to the registrant! Registrants also need to be 18 years or older to attend the Expo.*

YES, I would like to receive my personalized customer invitation link

If you have any questions regarding the personalized customer invitation links you can contact Mr. Jasper van Dijk directly at: jasper@hpp.nl

ORDER CONFIRMATION
Please note that, if applicable, sending back this order form automatically means that you agree that the order will be placed and/or invoiced.

ELECTRICAL OUTLETS		ORDER FORM 9 NON-OBLIGATORY	
		To be returned before: Friday April 25th, 2025	
CONTACT	EMAIL	PHONE	FAX
Mrs. Patricia Peláez	patricia@hpp.nl	+31-20-6622482	+31-20-6752326

Company Name:	
Stand number:	
Contact Person:	

Please note: If you ordered the Stand construction package through your contract or through order form 4 of this manual, 1 outlet is already included on your package. Floorspace only stands do not have any electrical outlets included!

Kenya's electrical current is 240/50 (Volts/Hz). The outlet includes electrical connection with capacity of 1000 watts.

YES, I would like to order (extra) outlets.

Quantity	Description	Price in €	Total Price in €
	240/50 (Volts/Hz) outlet	€ 50.00	€



ORDER CONFIRMATION
 Please note that, if applicable, sending back this order form automatically means that you agree that the order will be placed and/or invoiced.

FURNISHINGS		ORDER FORM 10A NON-OBLIGATORY	
To be returned before: Friday April 25th, 2025			
CONTACT	EMAIL	PHONE	FAX
Mrs. Patricia Peláez	patricia@hpp.nl	+31-20-6622482	+31-20-6752326

Company Name:	
Stand number:	
Contact Person:	

If you wish to rent any of these additional furniture or appliances for your stand, please fill out the form bellow:

Image	Description	Code	QTY	Unit price in €	Total Price in €
	Chair (Black)	CC-01		€ 25.00	€
	White Leather Sofa (single-seater)	SS-01		€ 115.00	€
	White Leather Sofa (two-seater)	SS-02		€ 165.00	€
	White Leather Sofa (three-seater)	SS-03		€ 255.00	€
	Bar Stool	BS-01		€ 45.00	€
	High table	HT-01		€ 60.00	€
	Round table Ø 70cm, √ 78cm	T-01		€60.00	€
	Ring hook screw	RS-04		€ 5.00	€
Total amount					€







Please note: Prices are subject to 21% VAT, if applicable.

ORDER CONFIRMATION
Please note that, if applicable, sending back this order form automatically means that you agree that the order will be placed and/or invoiced.

FURNISHINGS		ORDER FORM 10B NON-OBLIGATORY To be returned before: Friday April 25th, 2025	
CONTACT	EMAIL	PHONE	FAX
Mrs. Patricia Peláez	patricia@hpp.nl	+31-20-6622482	+31-20-6752326

Company Name:	
Stand number:	
Contact Person:	

If you wish to rent any of these additional furniture or appliances for your stand, please fill out the form bellow:

Image	Description	Code	QTY	Unit price in €	Total Price in €
	Lockable Counter White Top. Doors: Black, Yellow, green, Red and Blue. (Please circle color of choice)	LC-01		€ 95.00	€
	Wooden Plinth (40cm x 40cm x 50cm)	WP-01		€ 75.00	€
	Wooden Plinth (40cm x 40cm x 75cm)	WP-02		€ 80.00	€
	Wooden Plinth (40cm x 40cm x 100cm)	WP-03		€ 85.00	€
	Reception Counter (Curved)	RC-01		€ 85.00	€
	Refrigerator (100cm height)	RF-01		€ 100.00	€
	Flat shelf (20cm x 100cm)	FS-01		€ 25.00	€
	Brochure holder (4 x A4 pocket)	LT-05		€ 35.00	€
	Adjustable spotlight (Only available for Stand Construction Packages)	AS-01		€ 25.00	€
Total amount					€



Please note: Prices are subject to 21% VAT, if applicable.

ORDER CONFIRMATION
Please note that, if applicable, sending back this order form automatically means that you agree that the order will be placed and/or invoiced.

AUDIOVISUALS & SUPPLIES		ORDER FORM 11 NON-OBLIGATORY	
		To be returned before: Friday April 25th, 2025	
CONTACT	EMAIL	PHONE	FA
Mrs. Patricia Peláez	patricia@hpp.nl	+31-20-6622482	+31-20-6752326

Company Name:	
Stand number:	
Contact Person:	

If you wish to rent any of these additional furniture or appliances for your stand, please fill out the form bellow:

Image	Description	Quantity	Unit price in €	Total Price in €
	65" smart TV (with or without stand)		€ 650.00	€
	42" LCD Screen		€ 335.00	€
	43" smart TV (with or without stand)		€ 350.00	€
	DVD Player		€ 70.00	€
			Total amount	€

Please note: Prices are subject to 21% VAT, if applicable.

ORDER CONFIRMATION
Please note that, if applicable, sending back this order form automatically means that you agree that the order will be placed and/or invoiced.

STORAGE IN YOUR STAND		ORDER FORM 12 NON-OBLIGATORY	
		To be returned before: Friday April 25th, 2025	
CONTACT	EMAIL	PHONE	FAX
Mrs. Patricia Peláez	patricia@hpp.nl	+31-20-6622482	+31-20-6752326

Company Name:	
Stand number:	
Contact Person:	

Please note: This form only needs to be filled out only if you ordered the stand construction package through your contract or through order form 4 of this manual.

Description	Price in € per m ²	Total Price in €
<input type="checkbox"/> Storage 1m x 1m with lockable door	€ 135.00	€
<input type="checkbox"/> Storage 2m x 1m with lockable door	€ 175.00	€
Total amount		€

Please draw your stand to scale and indicate where you would like to have your storage:

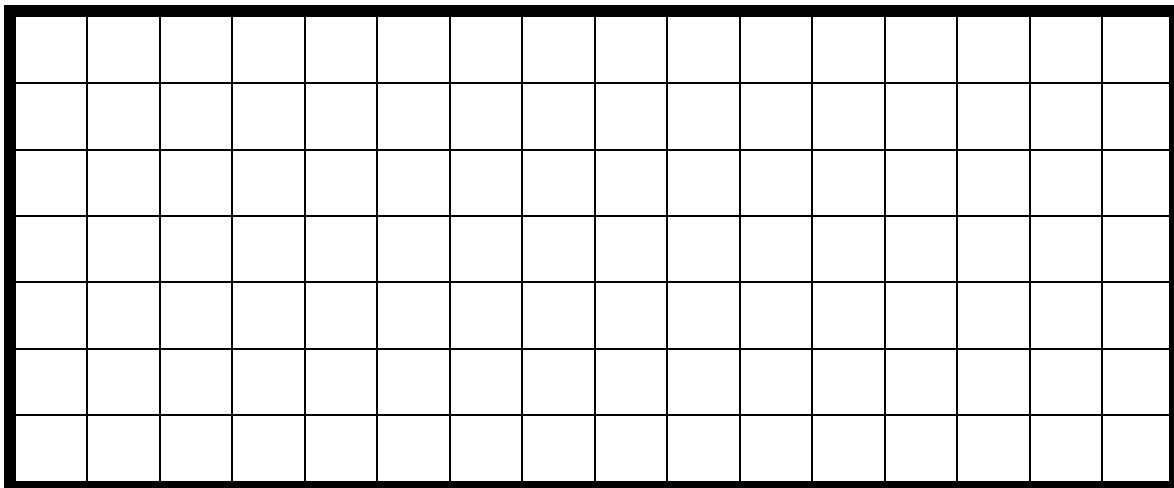

Please note: Prices are subject to 21% VAT, if applicable.

ORDER CONFIRMATION
Please note that, if applicable, sending back this order form automatically means that you agree that the order will be placed and/or invoiced.

FLOWER DESIGNING		ORDER FORM 13 NON-OBLIGATORY To be returned before: Friday April 25th, 2025	
CONTACT	EMAIL	PHONE	FAX
Mrs. Patricia Peláez	patricia@hpp.nl	+31-20-6622482	+31-20-6752326

Company Name:	
Stand number:	
Contact Person:	

You can request professional flower designing for your stand on IFTEX 2025. HPP offers the services of its professional team of designers as an extra way to highlight your participation.

The service includes: rental of wooden pillar (colour of your own choice), vase rental, flower designing, daily maintenance of the flower design and disposal of the flowers after the exhibition.

YES, I would like to be contacted for special flower designing needs and receive a quote.

ORDER CONFIRMATION
Please note that, if applicable, sending back this order form automatically means that you agree that the order will be placed and/or invoiced.

ADDITIONAL PARTY TICKETS		ORDER FORM 14 NON-OBLIGATORY	
		To be returned before: Friday April 25th, 2025	
CONTACT	EMAIL	PHONE	FAX
Mrs. Patricia Peláez	patricia@hpp.nl	+31-20-6622482	+31-20-6752326

Company Name:	
Stand number:	
Contact Person:	

The official party of IFTEX 2025 will take place on Wednesday, June 4th from 19:00 hrs. to 23:00 hrs.

Exhibitors and visitors will enjoy delicious food, drinks, music, whilst having the chance to spend time with each other.

Regular exhibitors will receive 4 entry tickets free of charge per stand regardless of stand size.

Additional tickets can be ordered at a price of € 35.00 per ticket via this form and will be invoiced after the show.

YES, I would like to order additional party tickets.

Quantity	Description	Ticket Price in €	Total Price in €
	Party Tickets	€ 35.00	€

<p align="center">ORDER CONFIRMATION</p> <p>Please note that, if applicable, sending back this order form automatically means that you agree that the order will be placed and/or invoiced.</p>
--